



Government  
of Canada

Office of Critical  
Infrastructure Protection and  
Emergency Preparedness

Gouvernement  
du Canada

Bureau de la protection  
des infrastructures essentielles  
et de la protection civile



# Basic Rescue Skills



Canada

---

**THIS REVISED BOOKLET WAS PRODUCED BY  
OFFICE OF CRITICAL INFRASTRUCTURE PROTECTION AND  
EMERGENCY PREPAREDNESS IN CONSULTATION WITH**



St. John Ambulance Saint-Jean



City of Toronto Fire Academy



SCR Emergency  
Measures Consultants  
and  
The Volunteer Group  
Sauvetage Canada Rescue



Canadian Association of Fire Chiefs

Christopher J. Naum  
L.A. Emergency Management + Training Consultants  
Syracuse, New York, USA

*Cette publication est aussi disponible en français.  
Elle s'intitule : Les techniques élémentaires du sauvetage*

Illustrations in Section 7  
© 1997 Priory of Canada of the Most Venerable  
Order of the Hospital of St. John of Jerusalem.  
All rights reserved.

© Public Works and Government Services Canada 2002  
Catalogue No. D82-22/2002E  
ISBN 0-662-33184-2



---

## INTRODUCTION

---

In natural or technological disasters, people could be trapped in the wreckage of their homes or places of work. Many of them could die unless rescued quickly. Although specialized dog teams and sophisticated listening devices are available to help search for trapped people, the bulk of rescue work is done by local first responders: fire, ambulance, and police personnel, who are trained and certified. The first responders are often assisted by the general public; but it takes more than just willing hands to save lives. Untrained, unorganized people may endanger themselves and those they are trying to rescue. *(In the 1985 Mexico City earthquake, more than 130 untrained and unequipped rescuers died in their attempt to save other lives.)*

**Those wishing to assist should await the arrival of the first responders and follow their instructions.**

**It is important to note that anyone entering a damaged structure should ask themselves whether or not the damage may be the result of a criminal act. If that possibility exists, it is of the utmost importance that the integrity of the crime scene be preserved to assist law enforcement officials in the prosecution of the criminals. If you must enter the structure in order to rescue someone, only circulate where absolutely necessary, and try moving as little as possible along the way. Take note of the things you have moved, and report it to the officials in charge.**

The purpose of this booklet is to provide basic information about rescue work in damaged structures to individuals interested in the subject. This booklet does not constitute training, nor is it

a complete technical manual, but it will familiarize you with some of the skills required. You will need further training before you attempt to do any of the activities described in this booklet. The techniques described here may be learned and practised using the materials and know-how available in most communities in Canada.

Those who wish to study this subject in more detail should seek further instruction from their municipal and provincial/territorial emergency measures organizations or fire services. Training may also be obtained from non-governmental and volunteer organizations that are often involved in assisting authorities in emergency response. These organizations have experienced personnel capable of advising or training others for rescue work during a disaster.

**While early response is vital to the survival of disaster victims, the Office of Critical Infrastructure Protection and Emergency Preparedness (OCIPEP) does not endorse entry into damaged structures by untrained, uncertified individuals.**

**Disaster rescue, by its very nature is a high-risk activity. OCIPEP accepts no responsibility for any accident or injury caused by the misuse or misinterpretation of information contained in this booklet. The reading of this booklet alone cannot be considered adequate training for a rescuer. Knowledge must be linked with training, practical experience and strict adherence to safety.**

## SAFETY

Safety must be foremost in your mind. As such, it is important to communicate the location of collapsed structures or broken pipes to the authorities, thus allowing them to efficiently coordinate their rescue efforts. Rescue sites will often be unstable and hide many dangers: broken glass, protruding nails, weakened floors or stairs, downed electrical wires, escaping gas, broken sewer and water pipes. Structures that appear to be solid may not be. The dust generated by a collapse may contain dangers, as well as possibly cover up wounded or dead victims. Always wear the protective clothing described below, and avoid kneeling in the rubble.

Protect yourself from injury or death by staying in a safe area while waiting for the first responders after (if it is possible) having called them. They are the only ones who are trained and equipped to attempt such rescues. They are used to managing emergency sites and know where everyone is working at all times so that if there is an accident (explosion, building collapse) it is easier to reach the trapped person(s). If you wish to assist the first responders, you must follow their instructions exactly.

### Wearing protection:

There are three levels of protective clothing that should be used in rescue work.

#### 1st Normal protective clothing

Such clothing can be worn within an area that is not contaminated with gases, chemicals, flammable liquids, or any

radioactive materials, and includes goggles or face shields, coveralls, gloves, knee guards, boots, and an appropriate mask.

#### 2nd Full protective clothing

Clothing designed to prevent gases/vapours, liquids and solids from coming into direct contact with the skin and may include helmet, face mask, coat and pants (customarily worn by firefighters), gloves, rubber boots, bands (light-reflecting material) around waist, arms and legs, as well as coverings for other parts of the head not protected by the face mask or helmet.

#### 3rd Special protective clothing

Clothing specially designed to protect against a specific product hazard; for example, strong acids, radioactive materials, cryogenic gases or poisonous substances.

### Confined spaces:

Entry into confined spaces is one of the most hazardous tasks faced by rescue personnel.

A confined space:

- has limited access because of construction, location or contents
- has the capability of developing a buildup of hazardous gas/vapour/ dust/fumes, or an oxygen deficient atmosphere.

Entry into a confined space may require specialized equipment such as a self-contained breathing apparatus. Many community organizations provide awareness training for confined spaces and associated equipment.

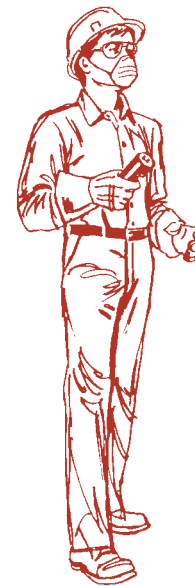

No matter how urgent the situation appears never enter a damaged building without first getting advice from a rescue expert. Take measures to control hazards and protect the rescuers first. Find out as much as you can about the structure you are about to enter. Use your power of **observation** and your ability to obtain **information** to enhance your safety and chances of success. Clearing debris from the opposite side of the building where people are less likely to be is a waste of precious time.

**Reconnaissance** is the first step in any rescue. Doing this first step well, will build a solid base for your rescue efforts. As you are conducting your reconnaissance try to locate casualties by calling out: "Rescue party here! Can you hear me? If you can't call out, tap in a series of three." Remember you won't help anybody by becoming a casualty yourself.

When you are given permission to enter a building, **always work with a partner**. Move slowly and test each step. Walk close to walls. Walk backward and close to walls when descending stairs.

Look out for unsafe walls. Blocked or jammed doors may be supporting debris on the other side. Look for weakened stairways, projecting glass fragments, splintered woodwork, projecting nails and spikes, escaping gas, flooding of basements and exposed wiring.



*Don't pull at projecting debris.*



*Don't smoke or light matches.*



*Don't touch any wires.*



*Don't throw debris aimlessly.*



*Don't create sparks or turn on the electrical power before first checking for the presence of gas.*

## HOW TO ACQUIRE THE “SUPPLEMENTARY SKILL”

To stay alive in rescue work you must understand the dangers you may meet and the precautions you must take. This is the “supplementary skill.”

In any neighbourhood, new buildings are constantly going up and old ones are being torn down. Study them. Learn how houses are made.

To get experience at working in voids, you can simulate collapsed houses by building “rafts” of old lumber. Lean them against walls to form the type of void you want. Pile on old crates, etc., to make it realistic. With two such rafts you can simulate any type of void (see page 7). You don't need a lot of money if you have a little imagination. Be sure it will not slip and injure someone before you practice this.

Rescue parties must often use whatever comes to hand. Learn to improvise. Make a list of the tools owned by neighbours. In particular, ladders, car jacks, axes, carpenters' tools, blankets, rope, first-aid supplies, garden tools, flashlights, helmets and gloves. Know where you can lay your hands on these tools at a moment's notice.



## SKILLS

Rescue is seldom a one-person effort. The ability to work as a team greatly enhances rescue efforts. Each individual in a team has experience or skills that may be useful. Disaster situations will bring people together who have never met before and unite them in the pursuit of the common goal of saving lives. Taking a few minutes to find out about the skills and experience of each member of the team is an important first step. The strength of a team lies in the versatility of its members and its ability to draw on this diversity of knowledge and experience.

Rescue workers should have a knowledge of ropes and knots and lashing. They should know how to use jacks and levers, chain hoists and ladders. They should learn about shoring up buildings with materials found on the spot. They should know how to handle casualties; a first-aid course is mandatory.

And, there is another thing they should learn... to stay alive while rescuing others. To do this they should understand something about the way buildings are constructed and how they collapse. They should learn to work as safely as possible in collapsed buildings, rubble and debris.

## BUILDING CONSTRUCTION

Most buildings are vulnerable to the effects of natural and technological disasters such as tornadoes, earthquakes, floods or explosions. But the extent of the damage depends on the type of disaster and the construction of the building.

Modern factories and office buildings for example, are framed in steel and are more resistant to unusual violence than neighbourhood business premises and homes. Beware of steel framed buildings that were recently on fire as they are more prone to collapsing. However, in a disaster such as a major earthquake, nearly every type of structure will be affected – some buildings will collapse and others will be left with weakened floors and walls. Remember that no matter what the scale of the damages, the techniques you use to rescue people remain the same.

Rescue workers should understand the patterns in which particular types of buildings collapse, both for their own safety and that of others. They must also keep untrained people from poking around in the rubble and debris. This may cause further collapse and harm trapped survivors.

## TYPES OF COLLAPSE AND FORMATION OF VOIDS

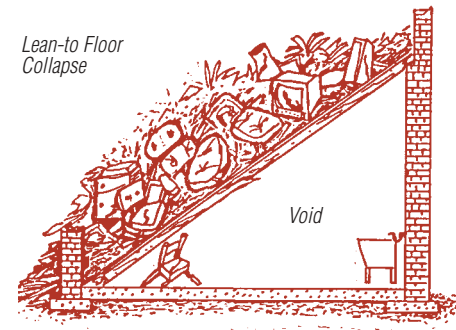
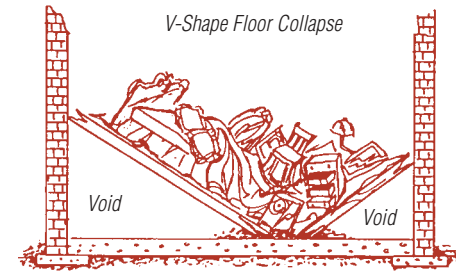

Most un-reinforced buildings collapse into more or less predictable patterns. Often the collapsing structure forms what are called **voids** where people may live for some time. Rescue workers should know how to locate and search these voids.

When a floor or roof or other large sections are supported on one side and collapse or sag on the other, they form a **lean-to collapse**.

The floors of a house or building are not constructed to carry tonnes of wreckage and as a result when the weight of heavy loads, such as furniture and equipment, or rubble and debris, is concentrated near the centre of a floor, a **V-type collapse** may occur.

When load-bearing external walls are weakened, destroyed or sucked outwards, the bulk of the debris falls on the ground or street. The floors, roof and some of the internal walls are deprived of support and collapse in a heap, separated only by the furniture and such portions of the walls as remain. This is called a **pancake collapse**. There may be voids formed by the furniture supporting the collapsed floors, and it is possible to crawl through these voids in comparative safety provided that such supports are not disturbed.

## KNOT TYING

**Running End:** the end you are working with in tying the knot

**Standing End:** the inactive end of the rope

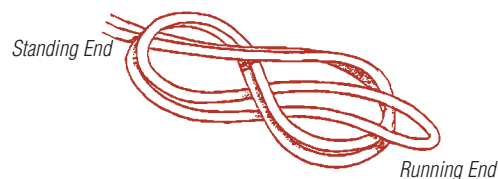
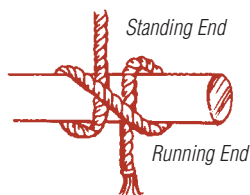

Although there are other knots and hitches that can be used in rescue work, the ones mentioned here are the most common and should be learned if you are to be a good rescue worker. Lives may depend on your being able to tie the right knot securely at the moment it's needed in light or dark, rain or shine. The use of natural fibre rope must be discouraged for the rescue of human life. For most other operations, natural fibre rope will suffice. Beware of ropes or straps that have been in the sun for some time, this may have weakened them.

### Simple Figure Eight Knot

This knot, from the figure eight family, is used mainly as a stop knot to prevent a free end of rope from running through a pulley or a block.

### Reef-Knot

A useful knot for general purposes. Used mainly for tying bandages.

### Clove Hitch

A quickly tied hitch which forms the basis of many securing knots. Useful for anchoring a rope to an object.

### Figure Eight-on-a-Bight

This is a widely used knot for tying/ attaching safety lines, persons on the rope, anchor lines, rescue devices and other equipment.

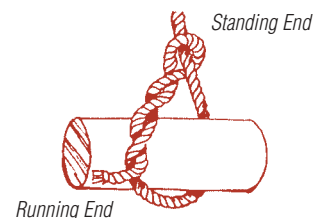
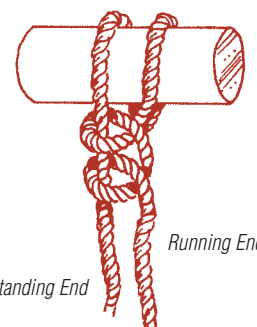
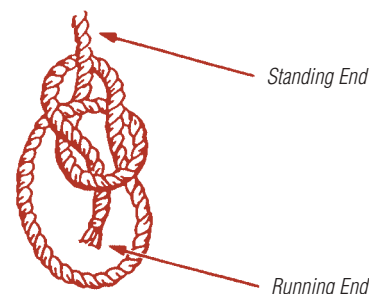
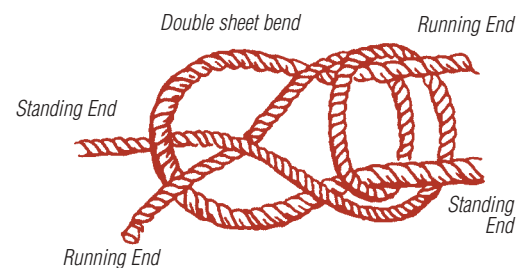

### Sheet Bend

A sheet bend is used for joining two ropes of different sizes.

The double sheet bend is more secure than the single sheet bend and is used when there is a great difference in the size of the rope as shown here. In rescue work, a double sheet bend is used for tying **all** ropes together, and can be used for joining ropes with chains.

Both knots have the advantage that they do not slip when the rope is wet.

### Bowline

The bowline makes a loop that won't tighten. Useful as a general purpose knot.

### Round Turn and Two Half Hitches

This knot is used for securing a rope to a spar, picket or anchorage. It is particularly useful where guy lines are secured to pickets and an adjusting knot is required.

### Timber Hitch

This is a quickly made temporary knot used to secure a rope to a spar, plank or pole. When lifting spars, planks or poles this knot should be used in conjunction with a half hitch placed at the upper end of the object being raised.

## RESCUE SKILL NO. 2

# USE OF LEVERS AND JACKS

When buildings collapse, people are frequently pinned under falling debris. Often this debris is too heavy to lift by hand. You must, therefore, be able to use levers and jacks.

Any sturdy piece of wood or metal will make a lever. Any solid object, such as a piece of masonry, makes a good fulcrum. Learn to improvise.

Make sure the fulcrum is placed so it won't sink under pressure. If necessary provide a wider base by putting the fulcrum on a board that will spread the load on the ground. If the load slips or your lever collapses, the victim may be injured even more. Always work from a secure position, keeping both feet on the ground.

The safest way to use a lever is to make a short lift at a time and, for safety, crib the progress as you go. (See Rescue Skill No. 3.)

A jack is a mechanical device designed to lift heavy loads. You can use it in a more confined space than a lever. But it also needs care and practice to be used safely. You can practice using levers and jacks with equipment like this. When using levers and jacks, be sure not to use metal against metal. Use rags or wood to prevent sparks and slippage.

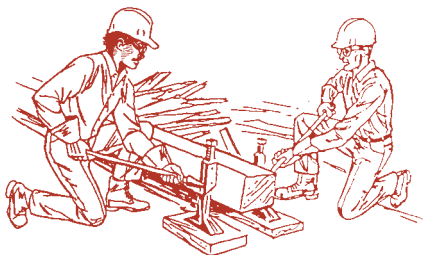
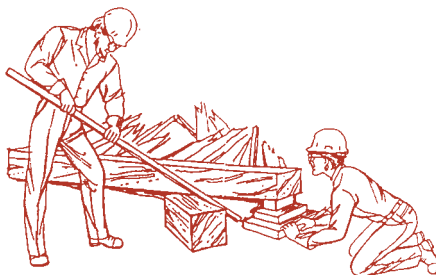

## RESCUE SKILL NO. 3

# CRIBBING

Cribbing is essential in many extrication operations. Its most common use is to stabilize objects. Wood selected for cribbing should be solid, straight, and free of major flaws such as large knots or splits. Cribbing surfaces should be free of any paint or finish because this can make the wood slippery, especially when it is wet. Cribbing can be made out of pieces of timber found in the debris and cut to size. Pieces of 2X2 (5 cm X 5 cm) and 4X4 (10 cm X 10 cm) as well as wedges cut in this size timber are very useful.

Cribbing involves multiple pieces of wood laid on the side and crossed. It spreads the load well and has many load transfer surfaces. It also has lateral stability depending on the ratio of width to height. The height should not be more than three times the width. (Note: pieces should not be less than two feet (60 cm) long.)



Wood Cribbing 4X4 (10 cm X 10 cm), 6X6 (15 cm X 15 cm) laid flat

Limit based on 500 PSI (pounds per square inch) crossgrain bearing (3,447.5 kPa)

4X4 crib capacity = 24000 lb. (10,886 kg)  
6X6 crib capacity = 60000 lb. (27,215.5 kg)

Note: using 3 pieces per layer as in 3X3 (7.5 cm X 7.5 cm) crosstie will double the capacity.

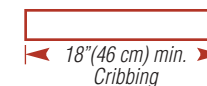

Do not stack cribbing more than two high in the same direction.

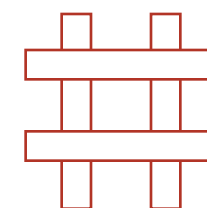

2X2 (5 cm X 5 cm) Crosstie

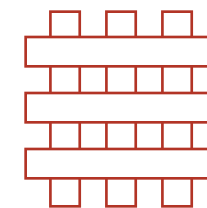

3X3 (7.5 cm X 7.5 cm) Crosstie

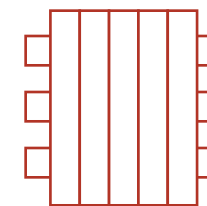

Crosstie Platform

## RESCUE SKILL NO. 4

# CHAIN HOIST AND FLOOR JACK

### Chain Hoist

Electric winches, chain hoists and cable come-alongs (manual winches) are found in most garages (and on farms), and a garage owner is a fine addition to your rescue team. Chain hoists are useful but are hard to work at night. They are not practical for horizontal pulls.

A snatch block can be opened from the side to allow easier threading of the rope/cable.

### Floor Jack

A hydraulic service jack (floor jack) has the advantage of no loose chain to get in the way. It takes little space and can be set up quickly. Remember not to use metal against metal and make sure that as you lift, you use a crib.

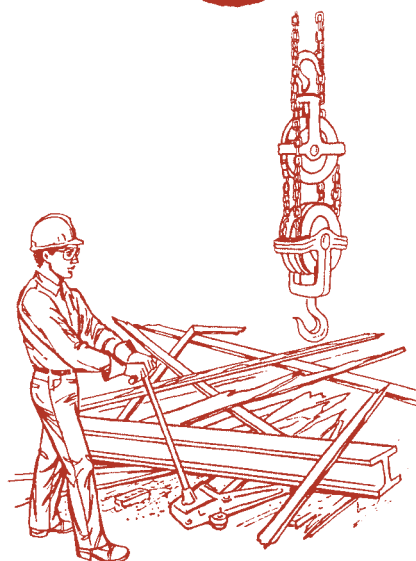
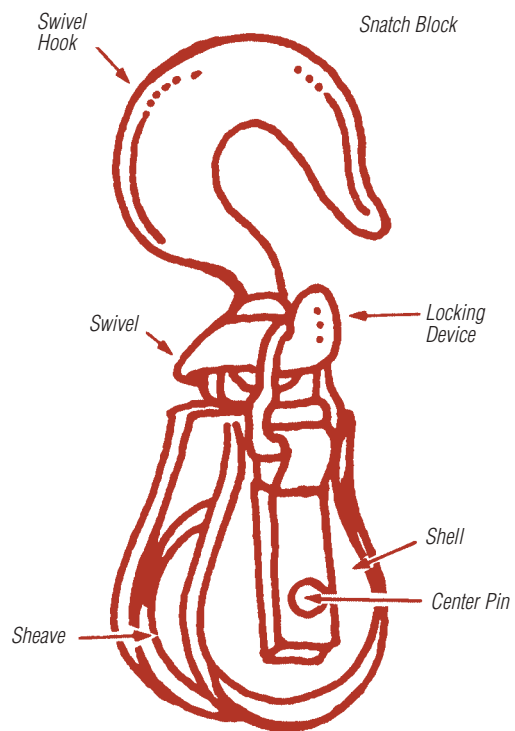

## RESCUE SKILL NO. 5

# LADDERS

Metal ladders are valuable pieces of rescue equipment. They can be used for bridges. When using a ladder as a bridge, make sure you have left plenty of overlap at each end (a minimum of three rungs). Place boards over the rungs to improve the footing. (Keep in mind that metal ladders conduct electricity so be careful where you place them.)

To erect a ladder, have one person "foot" it to prevent slipping. Another option is to lash the bottom of the ladder to some secure object.

Ladder as a Bridge

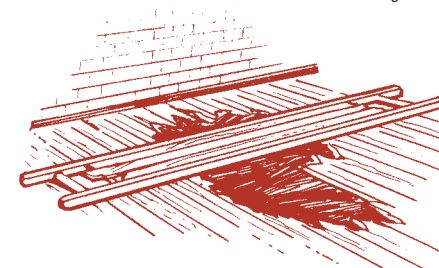

Securing and Anchoring Ladders

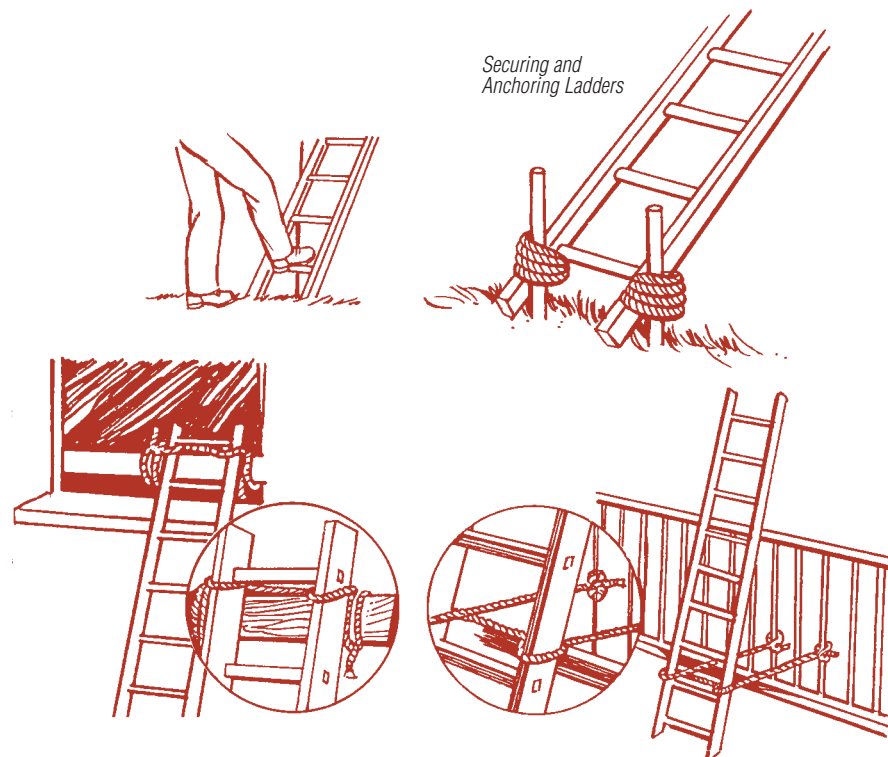



## To Climb a Ladder

Hold on to the rung, not the beam, unless you're carrying something. Stand on the centre of the rungs. Look up, not down.

If you must stand still on a ladder, lock yourself in place by passing one leg through the rungs, gripping the rung with the knee.

## Setting It Safely

To determine how far the base of the ladder should be placed from the wall, divide the working height by four. For added safety, when working from a height such as a rooftop, ensure that at least three rungs extend beyond the working height.

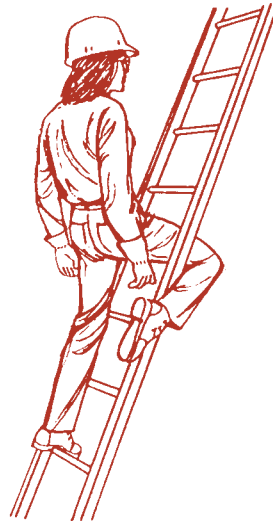

## RESCUE SKILL NO. 6

# STRUTTING AND SHORING

Once you've cleared fallen debris – or if a structure is liable to collapse further – you should shore it up with timbers. Strutting is the same process applied to doors and windows.

There are three main types of shoring – raking, flying and dead shore. Don't overdo things with shoring. The idea is support, not reconstruction.

## The Raking Shore

This is intended to hold a bulging wall from further collapse. As the value of this shore depends on its rigidity, common sense is the best guide in putting it in a firm place.

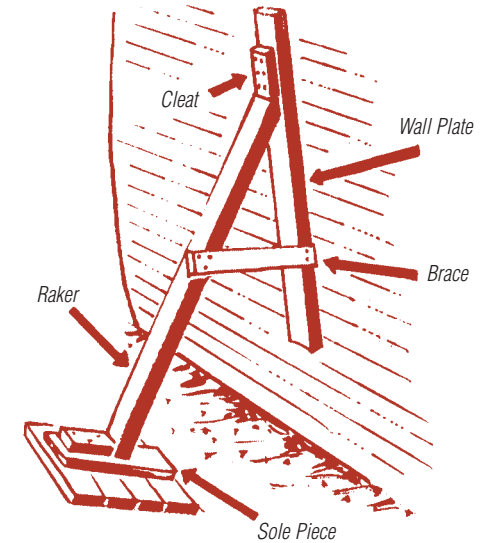

## The Flying Shore

This shore uses a sound wall to support a sagging wall. It can be used for walls up to 7.62 m (25 ft.) apart. You'll see from the diagram that it is really only a series of four raking shores, each based on the horizontal beam holding the wall plates in position. A raking shore can do almost anything a flying shore can do, and with a lot less fuss.

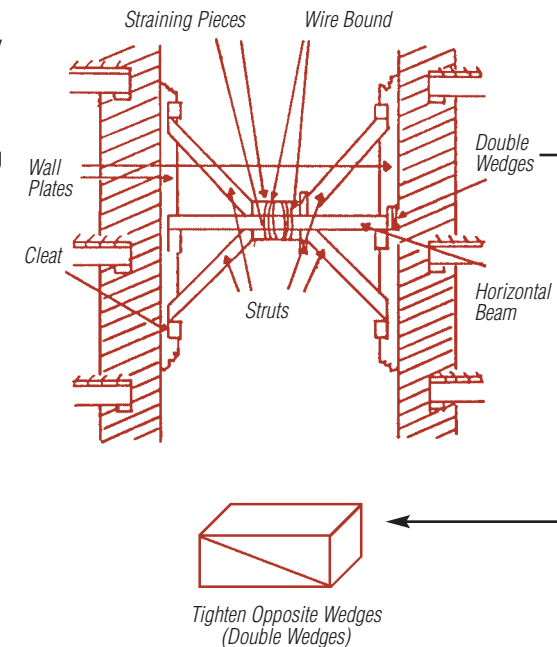

## The Dead Shore

This type of shore bears a lot of weight. Therefore the sole piece and head piece should be very solidly positioned. The dead shores or temporary columns in the form of upright struts, are used to provide safe working conditions for rescuers by supporting unsound floors or beams and providing vertical support for openings cut in masonry walls.

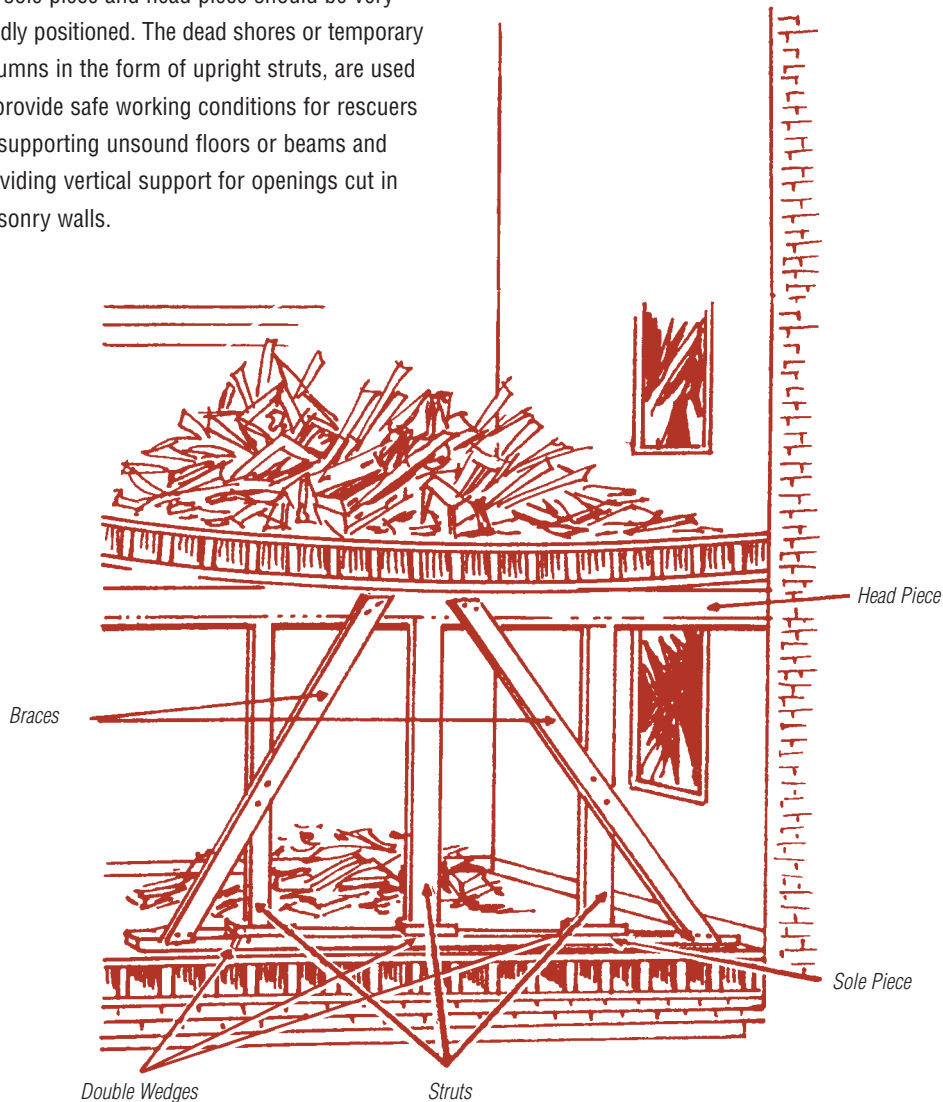

## RESCUE SKILL NO. 7

# EMERGENCY HANDLING OF CASUALTIES

The prime purpose of all rescue work is to get the injured people out of danger and to medical help as quickly as possible. When the number of casualties outnumbers the immediate help available the aim becomes one of trying to ensure the best use of time to effectively help the most people. This decision-making process is called "triage." In triage, those responding to the incident are called upon to examine all casualties quickly and rank them according to the level of need for both first aid and transportation to medical help.

In any rescue or multiple casualty situation, confusion may be evident. It is essential that individuals charged with helping injured people be able to remain calm and act quickly but carefully, always attentive to potential hazards to either themselves or other people in the area.

**In any situation where you suspect a possible head or spinal injury if the life of the casualty is not under immediate threat, seek the help of specialists. If it is essential to move the casualty and that your life is not in danger, maintain normal anatomical alignment (nose, belly button, inside of ankles). If the person is not in this position, get the help of qualified personnel.**

Try to establish quickly how many casualties are involved in the incident. Go to the nearest casualty, provided it is safe, and check for responsiveness. If the person does not answer

you or respond to your attempts to wake him, check to see if he is breathing. Your aim is to keep the casualty alive until medical help arrives. Do not waste time dealing with minor injuries until all casualties have been found and stabilized.

If the person is not breathing, try to find someone nearby who is able to do artificial respiration until help gets there. If the casualty is bleeding severely, apply a pressure bandage before moving to the next casualty. Remember, time is valuable. Give first aid for life-threatening conditions quickly and go to the next casualty.

## ONE-RESCUER METHODS

Never move the casualty any further than you have to. Scan the escape routes to determine the best method and route to carry the casualty. If you're alone and must move the casualty quickly, try one of the following rescue carries.

### Human Crutch

This method is only for casualties who can help themselves. It is an easy way to move the less seriously injured.



## Drag Carry

This carry is used to drag a casualty who is either lying on his back or in a sitting position. Ease your hands under the casualty's shoulders and grasp the clothing on each side, supporting the head between your forearms. Drag the casualty backward only as far as necessary for his/her safety. But be careful, make sure not to choke the casualties when pulling on their clothing.



## Blanket Drag

An alternate method to the drag carry, the rescuer can use a blanket to support and pull the casualty.



## Pick-a-Back

Simply lift the casualty from a standing or sitting position onto your back. Don't try it if the casualty is unconscious, or has arm injuries.



## Removal Downstairs

Don't try this if you suspect head/spinal injuries, or broken limbs. Use a mattress or rug under the person if one is available.

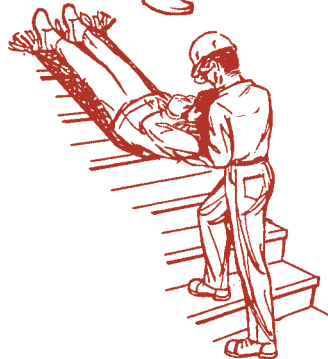

## Firefighter's Crawl

Use a triangular bandage, a torn shirt, etc., to tie the casualty's hands together, and place them around your neck. This way you can move a person much heavier than yourself.



## TWO-RESCUER METHODS

If there are two of you to do the carrying, try one of these emergency methods:

### Chair Lift

The chair carry can be used for a conscious or unconscious casualty, but not for suspected head/spinal injuries. For protection, secure the casualty's hands across his or her chest, and if the casualty is unconscious, secure the person to the chair.



### Two-hand Seat Carry

This is another way to carry a conscious casualty who can neither walk nor support the upper body. Make a hook with your fingers by folding them towards your palm and grab onto your partner's "hook". If you don't have any gloves, use a piece of cloth to protect your hand from the other person's nails. This is yet another good reason to wear gloves.



### Four-hand Seat Carry

This is also a good carry for a conscious casualty who can use hands and arms for support.





## MULTI-RESCUER METHODS

If there are more than two of you to do the job, there are a number of different methods that can be used to carry casualties.

### Three Person Lift and Carry

This is an excellent way of lifting a badly hurt person without complicating most injuries. The casualty can be carried forward, sideways or lowered onto a stretcher.



1.



2.



3.



4.

### Blanket Lift

Don't use this lift if head/spinal injuries are suspected.

1. Roll the blanket or rug lengthwise for half its width. Position bearers at the head and feet to keep the head, neck and body in line.
2. Kneel at the casualty's shoulder and position a bearer at the waist to help logroll the casualty onto the uninjured side. Turn the casualty as a unit so that his/her body is not twisted during the logroll.
3. Roll the casualty back over the blanket roll to lay face up on the blanket. Unroll the blanket and then roll the edges of the blanket to each side of the casualty. Get ready to lift the casualty – have bearers grip the rolls at the head and shoulders, and at the hips and legs.
4. Keep the blanket tight as the casualty is lifted and placed on the stretcher.

## IMPROVISED STRETCHERS

If a commercially prepared stretcher is not available, you can improvise one by using a tabletop, door, or two rigid poles and a blanket, or clothing. Don't use non-rigid stretchers for casualties with suspected head and spinal injuries.

### Blanket and Poles Stretcher

1. Place the blanket flat on the ground and place a pole one-third of the way from the end. Fold the one-third length of the blanket over the pole.
2. Place the second pole parallel to the first so that it is on the doubled part of the blanket, about 15 cm (6 in) from the doubled edge.
3. Fold the remaining blanket over the two poles. The casualty's weight on the blanket holds the folds in place.

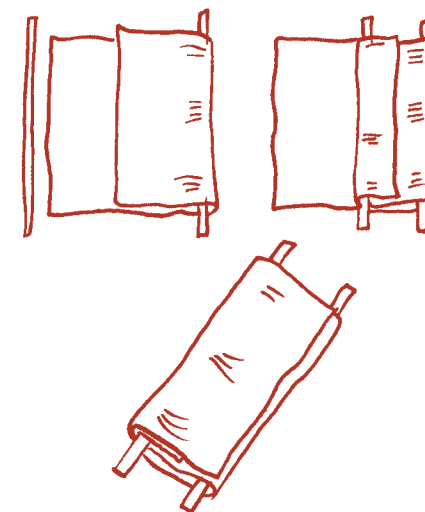

### Stretchers from Found Materials

Doors, short ladders, sheets of galvanized metal, etc. can all be used to improvise stretchers. Keep a good eye out for suitable materials.

Make sure the stretcher and casualty will clear passageways and that the stretcher is strong enough to hold the casualty.

**NOTE: Test an improvised stretcher with someone equal to or heavier than the casualty to ensure that it will hold.**

**Check the clearance of an improvised stretcher to ensure that it will pass through hallways, doors and stairways without harm to the casualty.**

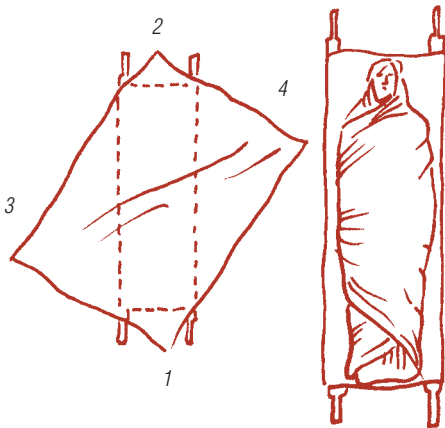

## BLANKETING STRETCHERS

One blanket can be used to wrap the casualty for warmth and provide easy access to the casualty's wounds.

Place a blanket diagonally on the length of the stretcher. Fold the overhanging edges and tuck them on both sides of the stretcher bed to keep them off the ground.

After the casualty has been placed on the stretcher, bring the bottom corner (1 in the figure) over the feet and tuck between the ankles. The corner at the head (2) is brought around the head and neck towards the chest. Cover the casualty with the two other sides (3 and 4).

## Lashing Casualty to Stretcher

Whenever casualties have to be carried over uneven ground or debris, they should be lashed to the stretcher using clove hitches. A clove hitch on the stretcher handle starts the lashing. This is followed by a series of half hitches positioned around the casualty at mid-chest, at the hip, where the legs join the torso, and just below the knee.

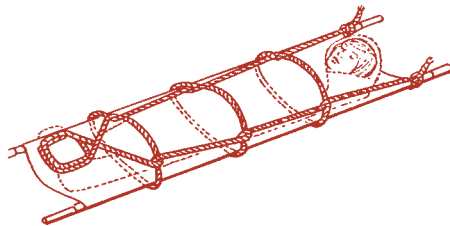

## CARRYING STRETCHERS

A stretcher should be carried by at least four people, normally facing the direction of travel, with the casualty's feet first. They should carry head first if going uphill or upstairs, and when loading into an ambulance or onto a bed. Remind rescuers that someone should keep watching the casualty, while they are transporting.

### Uneven Ground and Obstacles

When crossing uneven ground, a stretcher should be carried by four people and kept as level as possible. The rescuers must adjust the height of the stretcher to compensate for dips and rises in the terrain (Figure 1).

If the ground is unstable, the stretcher should be passed along a row of 6-8 people, rather than have bearers move over the rubble, especially when set down, since the lashing could tighten around the casualty.

If going through a doorway, the front bearers should move to the middle of the stretcher and let the front part protrude through the door. One rescuer at a time moves through the doorway, then regrips the stretcher.

Avoid crossing a wall or high obstacle, even if it means a longer carry. Where a wall must be crossed, follow these steps:

1. Lift the stretcher so that the front handles are supported by the wall. The people in the rear hold the stretcher level, while the front person crosses the wall.
2. All bearers lift together and move the stretcher forward until the rear handles rest on the wall. The people in the rear then cross the wall.

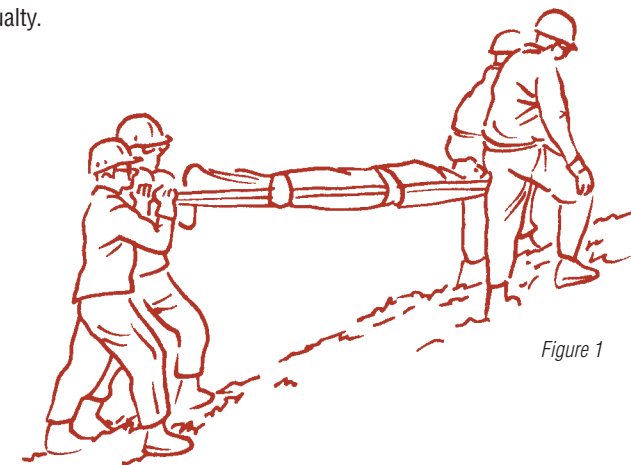

Figure 1

## EXTRICATION FROM A SITTING POSITION

Sometimes in earthquakes or blasts, casualties are found sitting in their vehicles. When there is an immediate danger and you are alone and must move a seated casualty from a vehicle, proceed as follows:

1. Disentangle the person's feet from the wreckage and bring the feet forward to exit. Ease your forearm under the person's armpit on the exit side, extending your hand to support the chin.
2. Ease the person's head gently backward to rest on your shoulder while keeping the neck as rigid as possible.
3. Ease your other forearm under the armpit on the opposite side and hold the wrist of the casualty's arm which is nearest the exit.
4. Establish a firm footing and swing around with the casualty, keeping as much rigidity in the neck as possible. Drag the casualty from the vehicle to a safe distance, with as little twisting as possible.



**Any casualty who has been injured may experience increased distress and pain as a result of rescue efforts. Remember never to move the casualty any further than necessary to wait safely for additional help. Do only what is necessary to ensure the casualty's safety and to preserve life. Continue to reassure the conscious casualty and, where available, have someone stay with him/her until help arrives.**

## FIVE STAGES OF RESCUE

No hard and fast rules can be laid down for rescue work but, generally speaking, five stages of rescue are followed by trained rescue parties.

### Stage 1 – Reconnaissance and Dealing with Surface Casualties

Examine the site. Deal with surface casualties. Gather all possible information about other occupants of the building.

### Stage 2 – Location and Removal of Lightly Trapped Casualties

Search immediately accessible areas for casualties who can be rescued with minimal effort. Maintain contact with casualties inside who can be seen or heard but who cannot be moved immediately.

Note: The use of trained air scenting dogs can greatly increase the likelihood of finding trapped and unconscious casualties.

Dogs used in this fashion should not wear collars or harnesses that might trap them when moving through debris. The paws should be checked regularly for injuries.

### Stage 3 – Exploration of Likely Survival Points

Search the ruins and rescue all persons who can be seen or heard. This may include a calling and listening period.

### Stage 4 – Further Exploration and Selected Debris Removal

Search farther into the ruins where the chances of trapped people remaining alive seem remote. This may include removing debris from the more likely places where casualties may be located.

### Stage 5 – Systematic Debris Removal

Strip selected areas of debris until all supposed casualties are accounted for. This includes removal of the dead and body parts. Identify buildings that have already been searched by using spray paint or signs. This method can also be used to mark buildings that may contain bodies.

## VISUAL TRAINING AIDS

Check with your provincial emergency measures organization for availability of the following training aids:

- Rescue Party
- Five Stages of Rescue
- Rescue Reconnaissance

## IMPROVISATION

You don't need a lot of expensive equipment to practise rescue work. Information on appropriate equipment and training may be available from your local emergency measures organization (page 28). Learn the proper procedures now so that you will be able to respond effectively in an emergency.

## SOME DOS AND DON'TS

---

### DO

#### Do It in the Dark

To be a good rescue worker you should master all the skills we've outlined in this booklet. You should be able to do them in the dark. Practise tying knots blindfolded and in cramped quarters.

In many places you may find a casualty simulation group. Take advantage of their services.

#### WHAT SHOULD BE DONE BEFORE AN EMERGENCY:

- Volunteer to get involved with your municipality's implementation of an Emergency Plan. Call City Hall and let them know you're interested.
- Make a family Emergency Plan by consulting our "Be Prepared Not Scared: Emergency Preparedness Starts With You" brochure.
- Prepare a Family Emergency Kit, in case you need to evacuate the premises.
- Get your First-Aid training.
- Know your emergency telephone numbers.
- Get all the safety equipment necessary to your protection (gloves, safety glasses, helmet, work boots, anti-dust mask).

#### WHAT TO DO:

- Think before you act, and be careful.
- Warn or have somebody warn the authorities about the damages and the number of casualties in your sector.
- Do a reconnaissance before you start work. This will not be time wasted.
- Walk as close as possible to the wall when on damaged stairs and upper floors.
- Use gloves when removing debris by hand.
- Be careful how you move debris from the vicinity of a casualty.
- Protect a casualty from falling debris and dust by using blankets, tarpaulins, corrugated iron sheets, etc.
- Keep off wreckage as much as possible and leave it undisturbed or the neutral voids may be destroyed by further collapse.
- Be careful how you remove debris and obstacles, especially from voids, to prevent further collapse.
- Exercise great care when using sharp tools in debris.
- It is often necessary to use props or struts to strengthen a floor loaded with debris before passing over or working underneath it.

## SOME DOS AND DON'TS

---

### DON'T

- In situations where the number of casualties is greater than the help available, do not waste time. Use your resources wisely.
- Examine a casualty before removal and give first aid for all life-threatening conditions only.
- Free the nose and mouth of a casualty from dust and grit to ease breathing.
- Keep a casualty warm to slow the progress of shock.
- Make sure that the stretcher is properly blanketed so that the casualty has the maximum amount of warmth and comfort.
- Use appropriate procedures to carry a stretcher over debris and obstacles.
- Keep a list of all casualties handled.
- Move an injured person without rendering first aid unless the casualty is in immediate danger.
- Smoke or strike matches in case there is a gas leak.
- Crawl over debris or disturb parts of the damaged structure unless you are compelled to by circumstances.
- Pull timber out of the wreckage indiscriminately or you may cause further collapse.
- Enter any site without informing the other members of your party, or if possible, without a companion to help in case of accident.
- Touch loose electrical wiring.
- Throw debris aimlessly – you may have to move it again.

## ADDITIONAL INFORMATION

---

For more information on emergency preparedness, please contact the Office of Critical Infrastructure Protection and Emergency Preparedness Canada or your provincial/ or territorial emergency measures organization.

### OFFICE OF CRITICAL INFRASTRUCTURE PROTECTION AND EMERGENCY PREPAREDNESS Public Affairs Division

122 Bank Street, 2nd floor  
Ottawa, Ontario

K1A 0W6

Telephone: (613) 944-4875

Toll free: 1-800-830-3118

Fax: (613) 998-9589

E-mail: [communications@ocipep-bpiepc.gc.ca](mailto:communications@ocipep-bpiepc.gc.ca)

Internet: [www.ocipep-bpiepc.gc.ca](http://www.ocipep-bpiepc.gc.ca)

### PROVINCIAL/TERRITORIAL EMERGENCY MEASURES ORGANIZATIONS

#### Newfoundland and Labrador

Emergency Measures Organization

Telephone: (709) 729-3703

Fax: (709) 729-3857

#### Prince Edward Island

Emergency Measures Organization

Telephone: (902) 888-8050

Fax: (902) 888-8054

#### Nova Scotia

Emergency Measures Organization

Telephone: (902) 424-5620

Fax: (902) 424-5376

#### New Brunswick

Emergency Measures Organization

Telephone: (506) 453-2133

Toll free: (800) 561-4034

Fax: (506) 453-5513

#### Québec

Direction générale de la sécurité civile et de la  
sécurité incendie

Telephone: (418) 646-7950

Fax: (418) 646-5427

Toll Free Emergency Number: 1 866 776-8345

Emergency Number: (418) 643-3256

Or one of the Direction générale de la sécurité  
civile regional offices:

Bas-Saint-Laurent-Gaspésie- Îles-de-la-Madeleine:  
(418) 727-3589

Saguenay-Lac-St-Jean-Côte-Nord:

(418) 695-7872

Capitale Nationale-Chaudière- Appalaches-  
Nunavik: (418) 643-3244

Mauricie-Centre-du-Québec: (819) 371-6703

Montréal-Laval-Laurentides- Lanaudière:  
(514) 873-1300

Montérégie-Estrie: (514) 873-1324

Outaouais-Abitibi-Témiscamingue-

Nord-du-Québec: (819) 772-3737

#### Ontario

Emergency Management Ontario

Telephone: (416) 212-3468

Fax: (416) 212-3498

#### Manitoba

Emergency Measures Organization

Telephone: (204) 945-4772

Toll free: 1-888-826-8298

Fax: (204) 945-4620

#### Saskatchewan

Saskatchewan Emergency Planning

Telephone: (306) 787-9563

Fax: (306) 787-1694

#### Alberta

Emergency Management Alberta

Telephone: (780) 422-9000

Toll free in Alberta, dial 310-0000-780-422-9000

Fax: (780) 422-1549

#### British Columbia

Provincial Emergency Program (PEP)

Telephone: (250) 952-4913

Fax: (250) 952-4888

#### Northwest Territories

Emergency Measures Organization

Telephone: (867) 873-7785

Fax: (867) 873-8193

#### Yukon

Emergency Measures Organization

Telephone: (867) 667-5220

Fax: (867) 393-6266

#### Nunavut

Nunavut Emergency Management

Telephone: (867) 975-5300

Fax: (867) 979-4221



# SAFE GUARD

SAFE GUARD is a national information program based on partnerships and aimed at increasing public awareness of emergency preparedness in Canada.

The SAFE GUARD program brings together government, private and voluntary organizations that are part of the emergency planning, response and recovery community.

The triangle depicted in the program logo is the international symbol of emergency preparedness. The jagged line evokes the maple leaf, Canada's internationally recognized symbol.

**SAFE  GUARD** is a program of the Office of Critical Infrastructure Protection and Emergency Preparedness.